

MOTOR SPECIFICATIONS

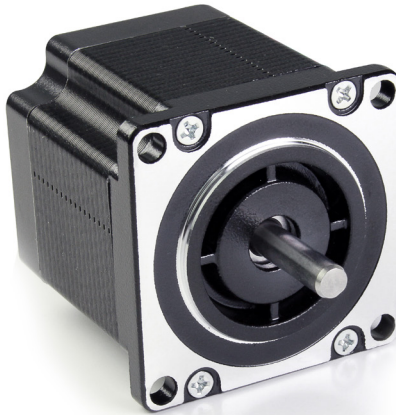

Part Number	X5718-055-22
Step Angle	1.8°
Frame Size (mm/in)	56.40/2.220
"A" Body Length (mm/in)	55.00/2.170
Current (Amps/Phase)	2.2
Holding Torque (oz-in/Nm)	325.71/23
Resistance (Ohms/Phase)	1.6
Rotor Inertia (g-cm ² / oz-in ²)	215/1.18
Number of Leads	4
Connection	Bipolar
Weight (lbs/kg)	1.32/0.60

DIMENSIONS

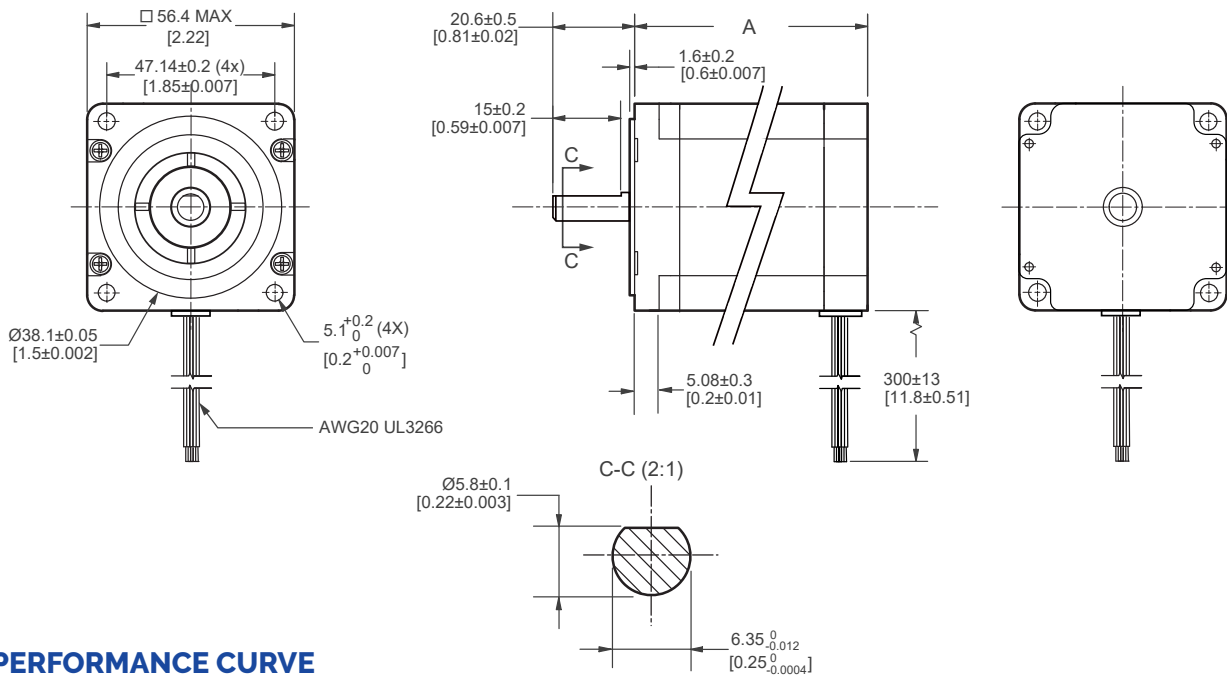

PERFORMANCE CURVE

X5718-055-22
 24 VDC, 2.2 AMP, 1/2 stepping

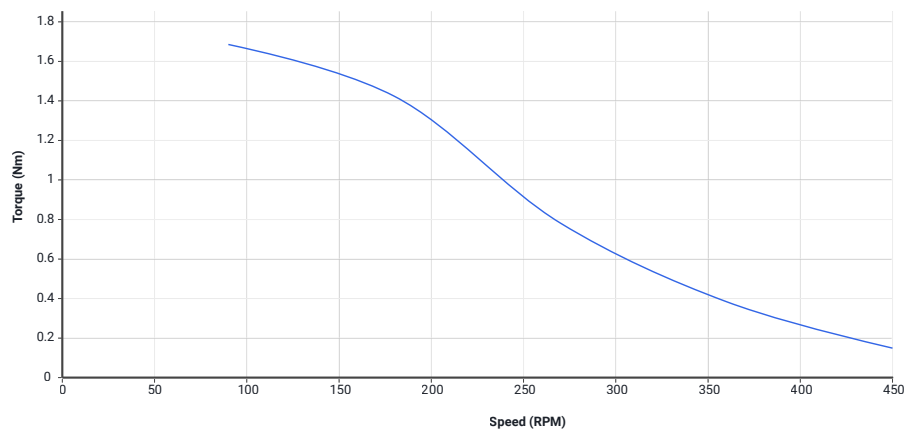

OPERATING SPECIFICATIONS

Radial Play	0.03 mm @ 0.45 kg (0.001 in @ 1.00 lbs)
End Play	0.08 mm @ 1.36 kg (0.003 in @ 3.00 lbs)
Shaft Run Out	0.05 TIR (0.002 TIR)
Concentricity of Mounting Pilot to Shaft	0.08 TIR (0.003 TIR)
Perpendicularity of Mounting Pilot to Face	0.08 TIR (0.003 TIR)
Max Radial Load at Dimension "K" from mounting face	6.80 kg (15 lbs)
Dimension "K"	13.97 mm (0.550 in)
Max Axial Load	4.08 kg (9.00 lbs)
Maximum Case Temperature	80°C (176°F) Maximum
Ambient Temperature	-20°C to 50°C (-4 to 122°F)
Storage Temperature	-20°C to 100°C (-4 to 212°F)
Humidity Range (%)	85% or less, non-condensing
Magnet Wire Insulation	Class B 130 ° C
Insulation Resistance	100M Ohm at 500 VCD
Dielectric Strength	500 VCD for 1 min.

OPERATION & USAGE TIPS

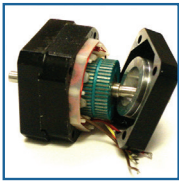

Do not disassemble motors; a significant reduction in motor performance will occur.

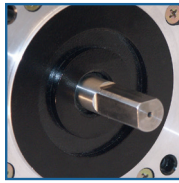

Do not machine shafts; this will have a negative effect on shaft run out and perpendicularity.

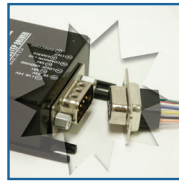

Do not disconnect motor from drive while in operation.

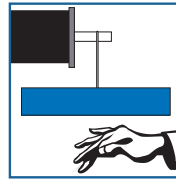

Do not use holding torque/detent torque of motor as a fail safe brake.

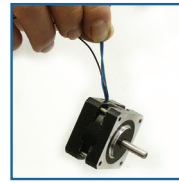

Do not hold motor by lead wires.



Do not exceed the rated current; this will burn the motor.

FAILURE TO COMPLY WITH THESE RECOMMENDATIONS WILL VOID ALL WARRANTY TERMS

RECOMMENDED

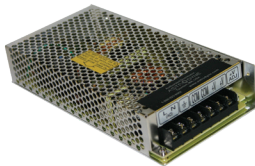

Power Supply
PW-150-24



Stepper Driver+Controller
R356



Stepper Driver
R710

Motion Control, Solved.

MOTOR ENGINEERING & MANUFACTURING



Optimized
For Your
Application



Quick
Prototype
Turnaround

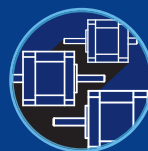

Small Batch
to OEM Volume
Production

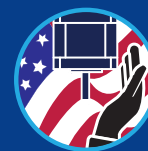

US Based
Support &
Manufacturing